

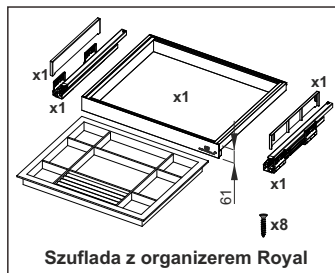

Elementy składowe

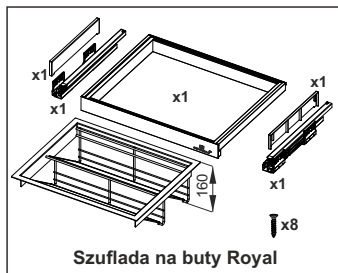
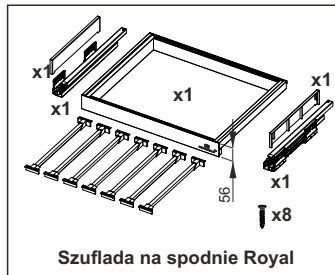
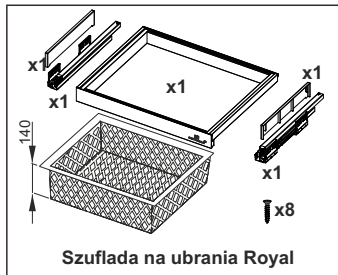

Uwaga: Zestawy zawierają wkręty $\varnothing 4 \times 16$

Wymiary korpusu

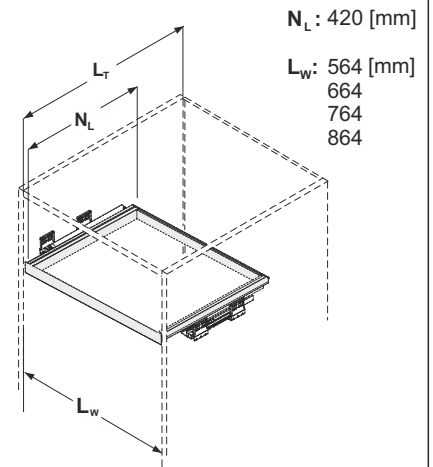

1. Montaż prowadnic

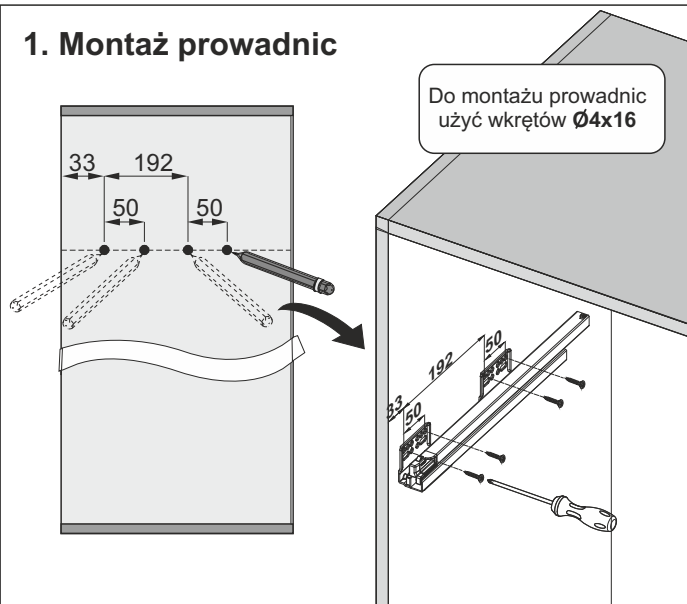

2. Montaż zaślepek prowadnic

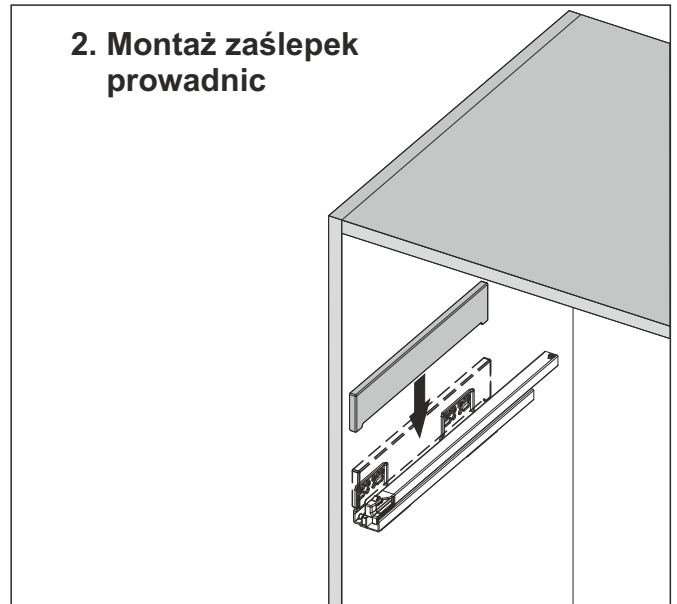

3. Regulacja

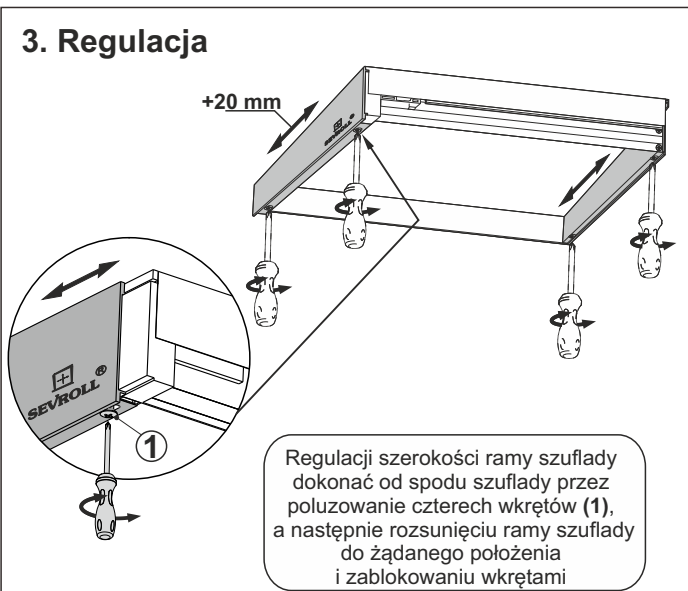

4. Montaż ramy szuflady do prowadnicy

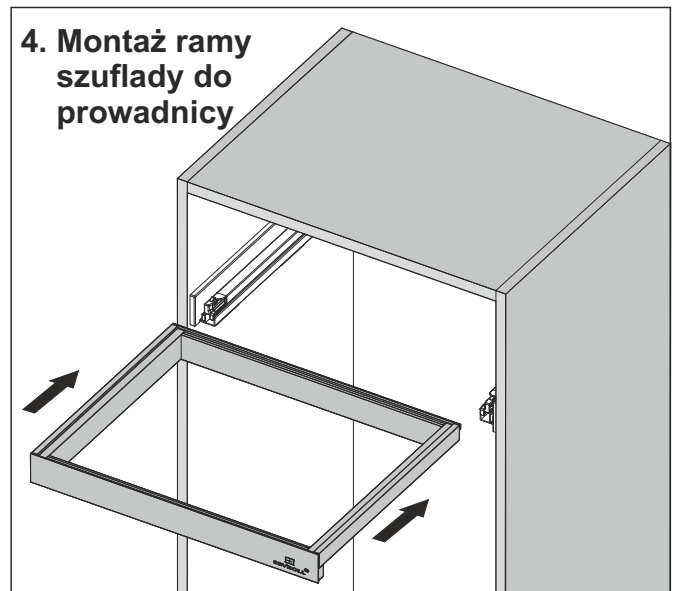



5. Montaż wypełnienia

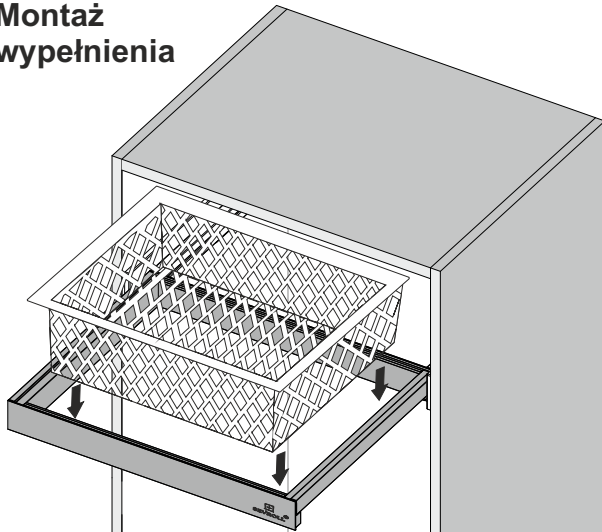

Sprawdzić płynność działania szuflady i w razie potrzeby dokonać korekty regulacji ramy

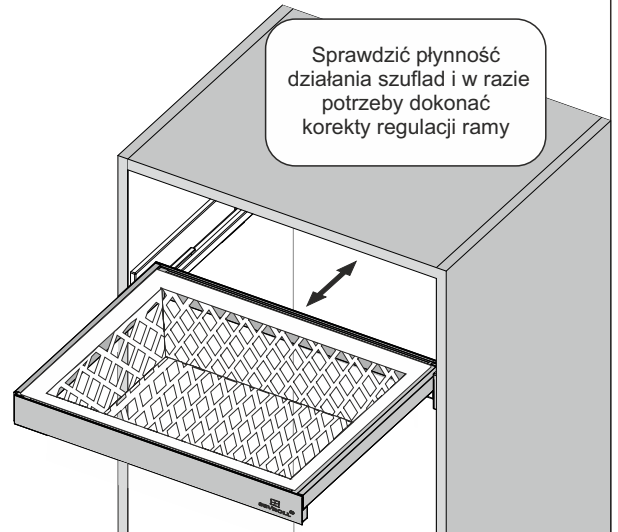

6. Demontaż szuflady

Wyjąć wypełnienie

