

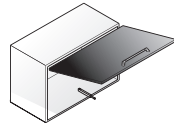

FREEspace pto

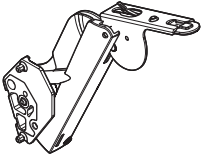

<http://support.kesseboehmer.de/freespace>

405457 0000



..... 1



..... 5



..... 2



..... 8



..... 4



..... 10



≥45 mm 4



..... 11



111358

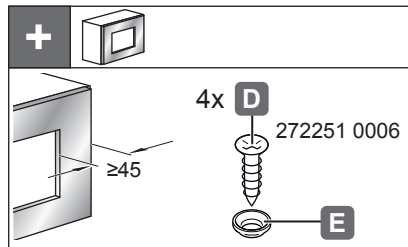
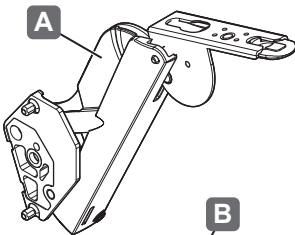

HDE 10.12.2019

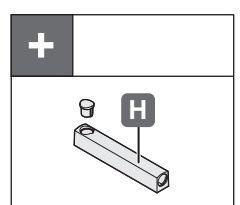
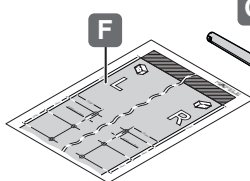
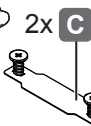
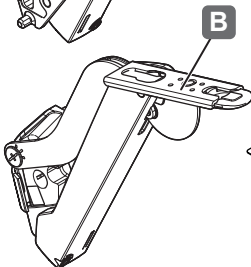

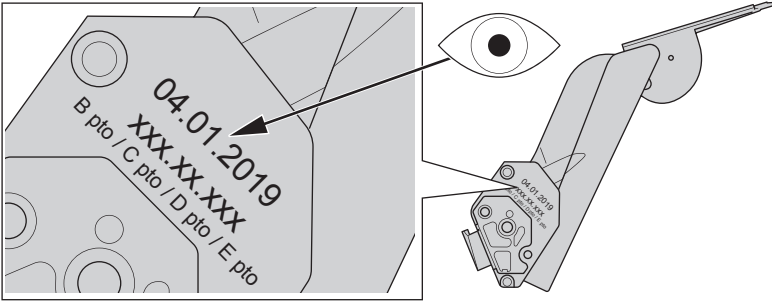

Free space B pto	272243 9966	272243 7035	272243 7500	272266 9005
Free space C pto	272244 9966	272244 7035	272244 7500	272267 9005
Free space D pto	272245 9966	272245 7035	272245 7500	272268 9005
Free space E pto	272246 9966	272246 7035	272246 7500	272269 9005

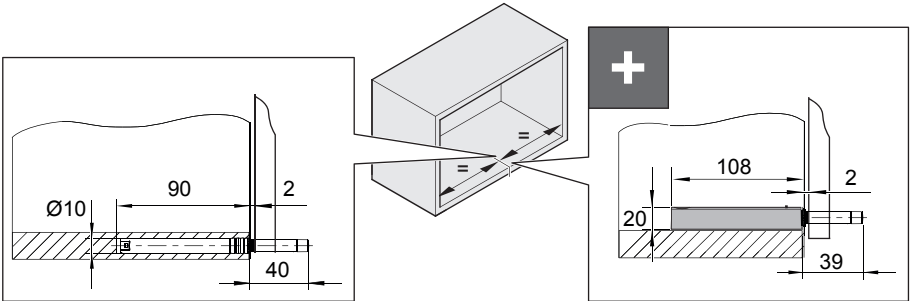
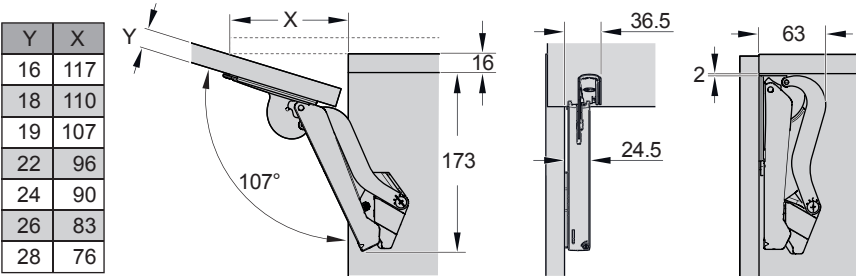

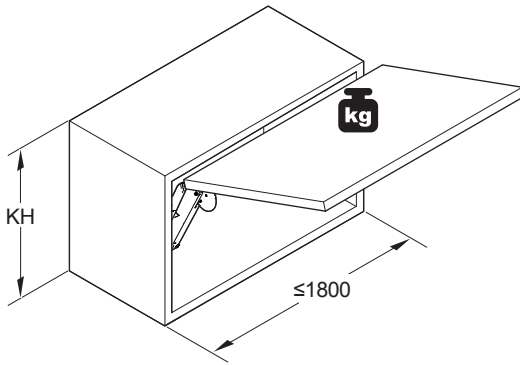

405457 0000

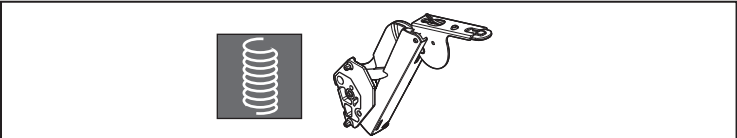

KH	B pto	C pto	D pto	E pto
225	2,3 – 4,3	3,8 – 7,1	6,4 – 9,3	9,2 – 13,4
250	1,9 – 3,9	3,4 – 6,4	5,8 – 9,1	8,3 – 12,6
275	1,9 – 3,5	3,1 – 5,8	5,3 – 8,2	7,5 – 12,0
300	1,7 – 3,2	2,8 – 5,3	4,8 – 7,5	6,9 – 11,0
325	1,6 – 3,0	2,6 – 4,9	4,4 – 7,0	6,4 – 10,2
350	1,5 – 2,8	2,4 – 4,6	4,1 – 6,5	5,9 – 9,5
375	1,3 – 2,6	2,2 – 4,3	3,8 – 6,0	5,5 – 8,8
400	1,2 – 2,4	2,1 – 4,0	3,6 – 5,6	5,2 – 8,3
425	1,1 – 2,3	2,0 – 3,8	3,4 – 5,3	4,9 – 7,8
450	1,0 – 2,1	1,9 – 3,5	3,2 – 5,0	4,6 – 7,3
475	1,0 – 2,0	1,8 – 3,4	3,0 – 4,7	4,3 – 7,0
500	0,9 – 1,9	1,7 – 3,2	2,9 – 4,5	4,1 – 6,6
525	0,9 – 1,8	1,6 – 3,0	2,7 – 4,3	3,9 – 6,3
550	0,8 – 1,7	1,5 – 2,9	2,6 – 4,1	3,7 – 6,0
575	0,8 – 1,7	1,4 – 2,8	2,5 – 3,9	3,6 – 5,7
600	0,8 – 1,6	1,4 – 2,7	2,4 – 3,7	3,4 – 5,5
625	0,7 – 1,5	1,3 – 2,5	2,3 – 3,6	3,3 – 5,3
650	0,7 – 1,5	1,3 – 2,4	2,2 – 3,5	3,2 – 5,1

HDE 10.12.2019

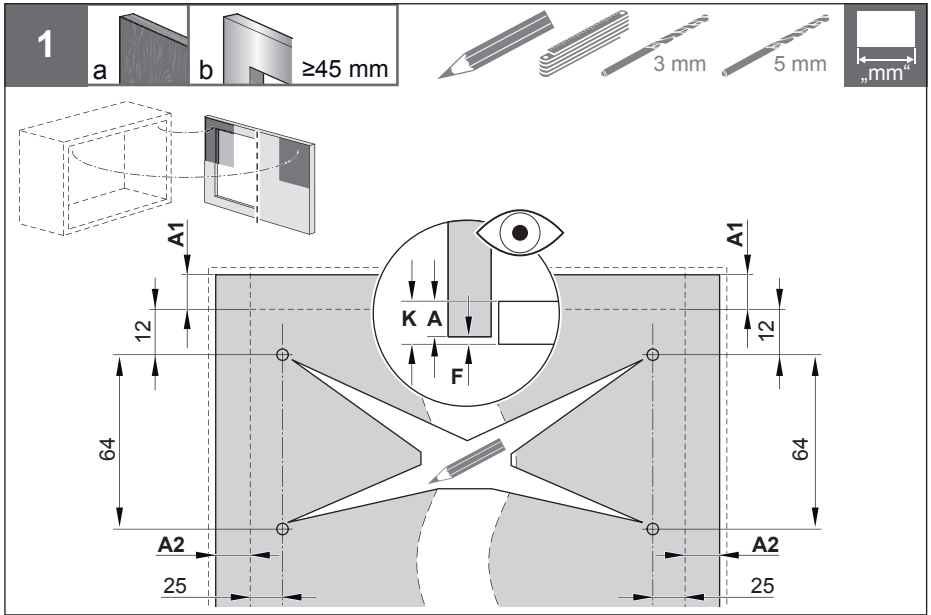

405457 0000

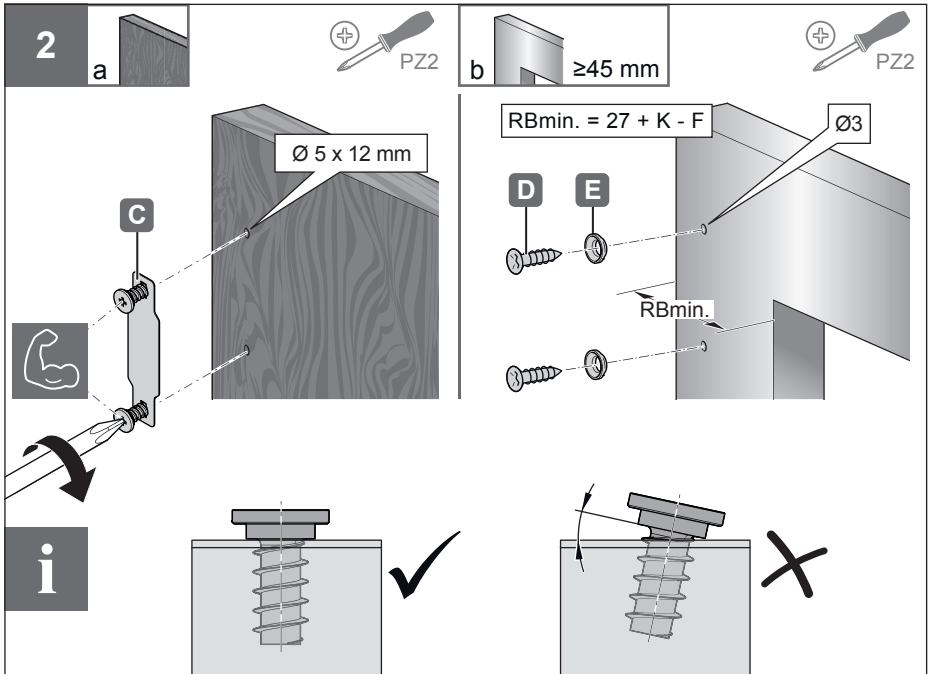

HDE 10.12.2019



3

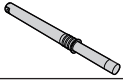

10 mm

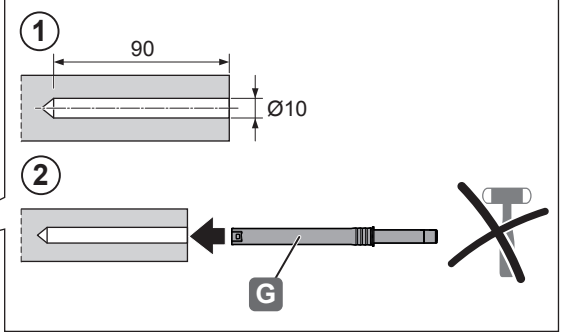
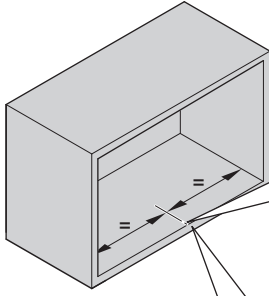

405457 0000

+

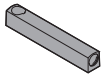

1

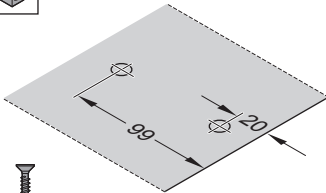

2

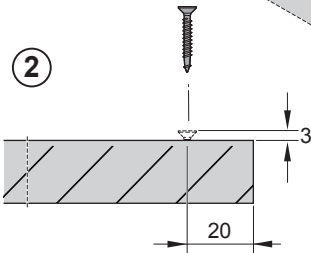

3

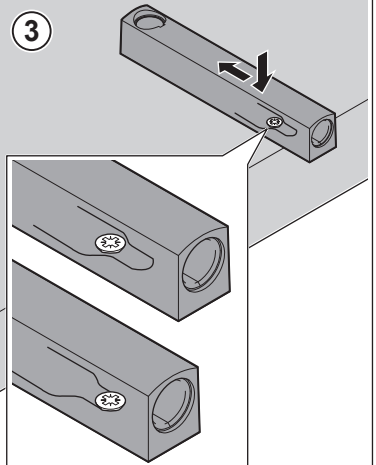

4

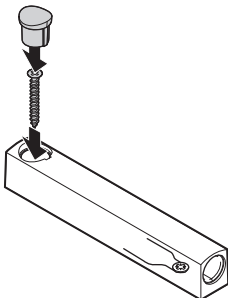

5

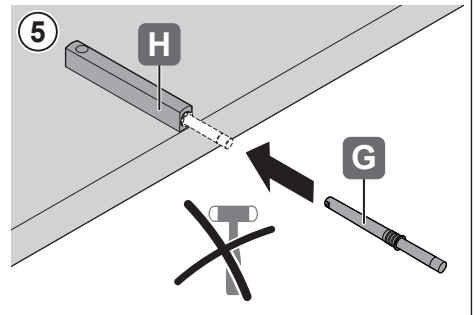

HDE 10.12.2019



4

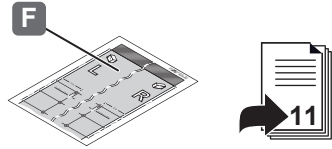
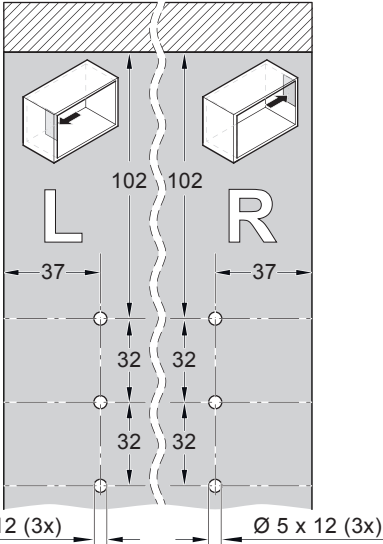

406457 0000

5

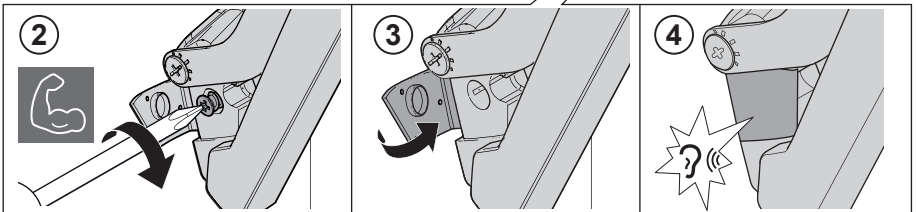
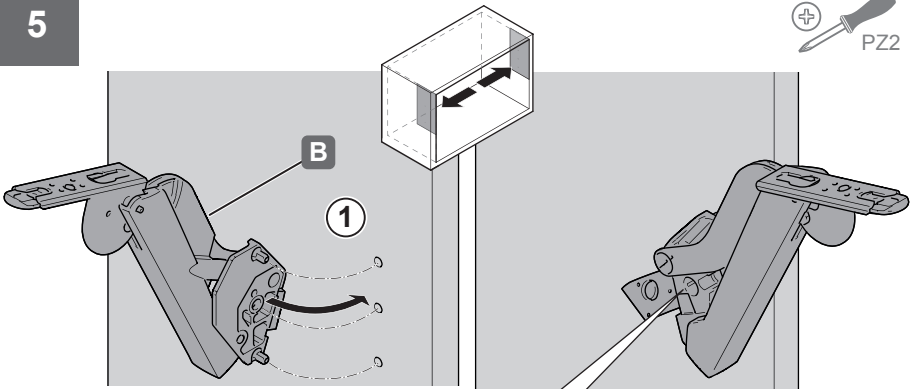

HDE 10.10.2019



6

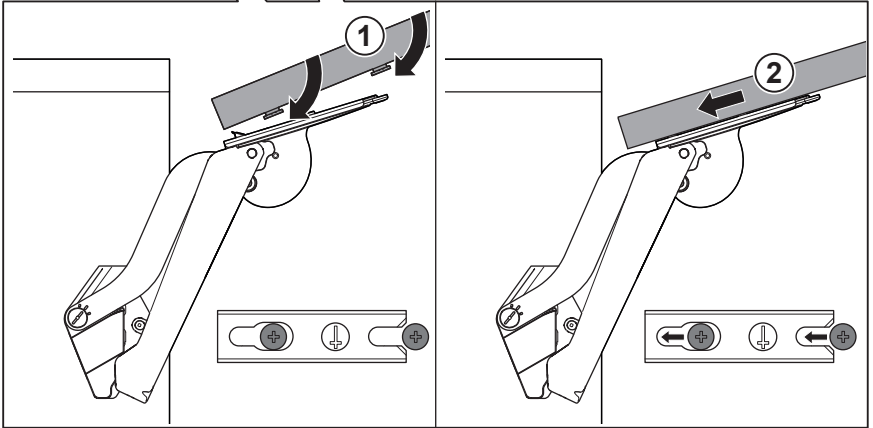
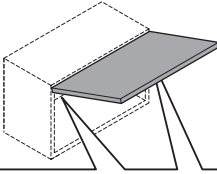

406457 0000

i

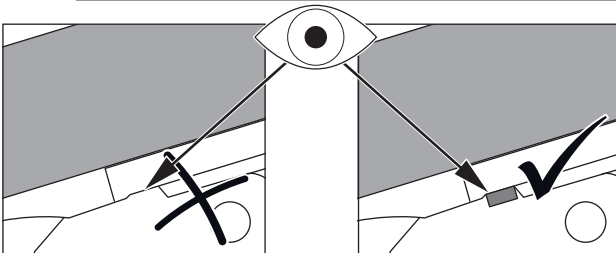
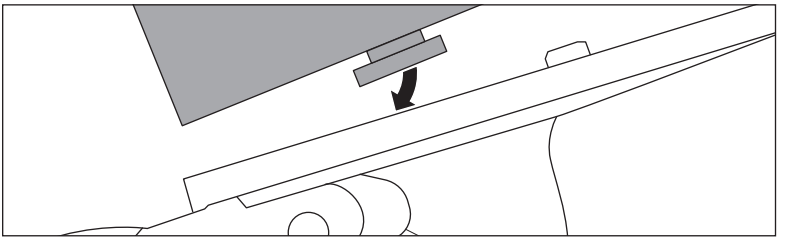

HDE 10.12.2019

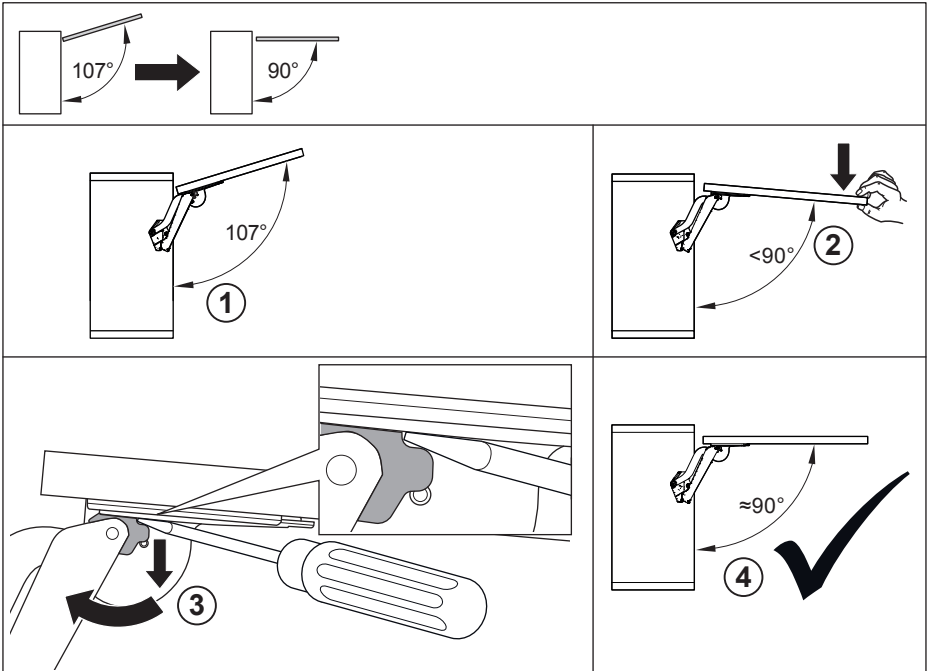

405457 0000

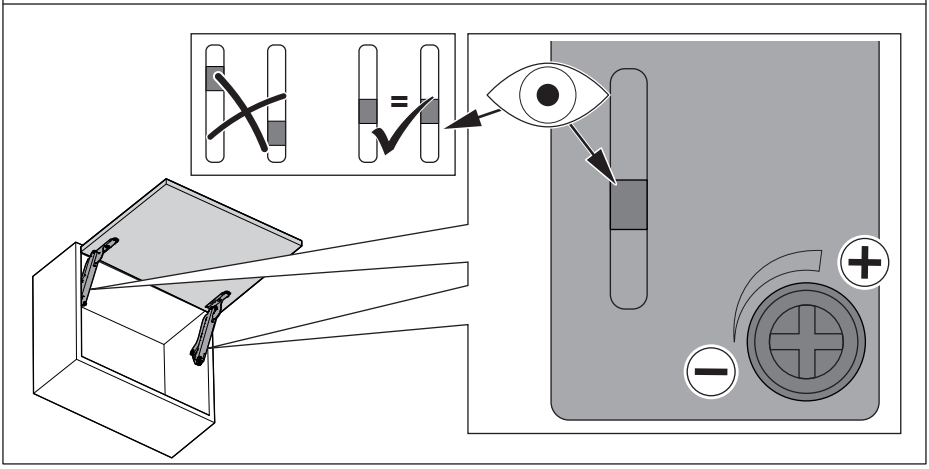
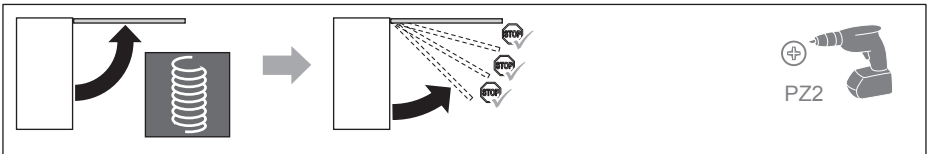

HDE 10.12.2019



405457 0000

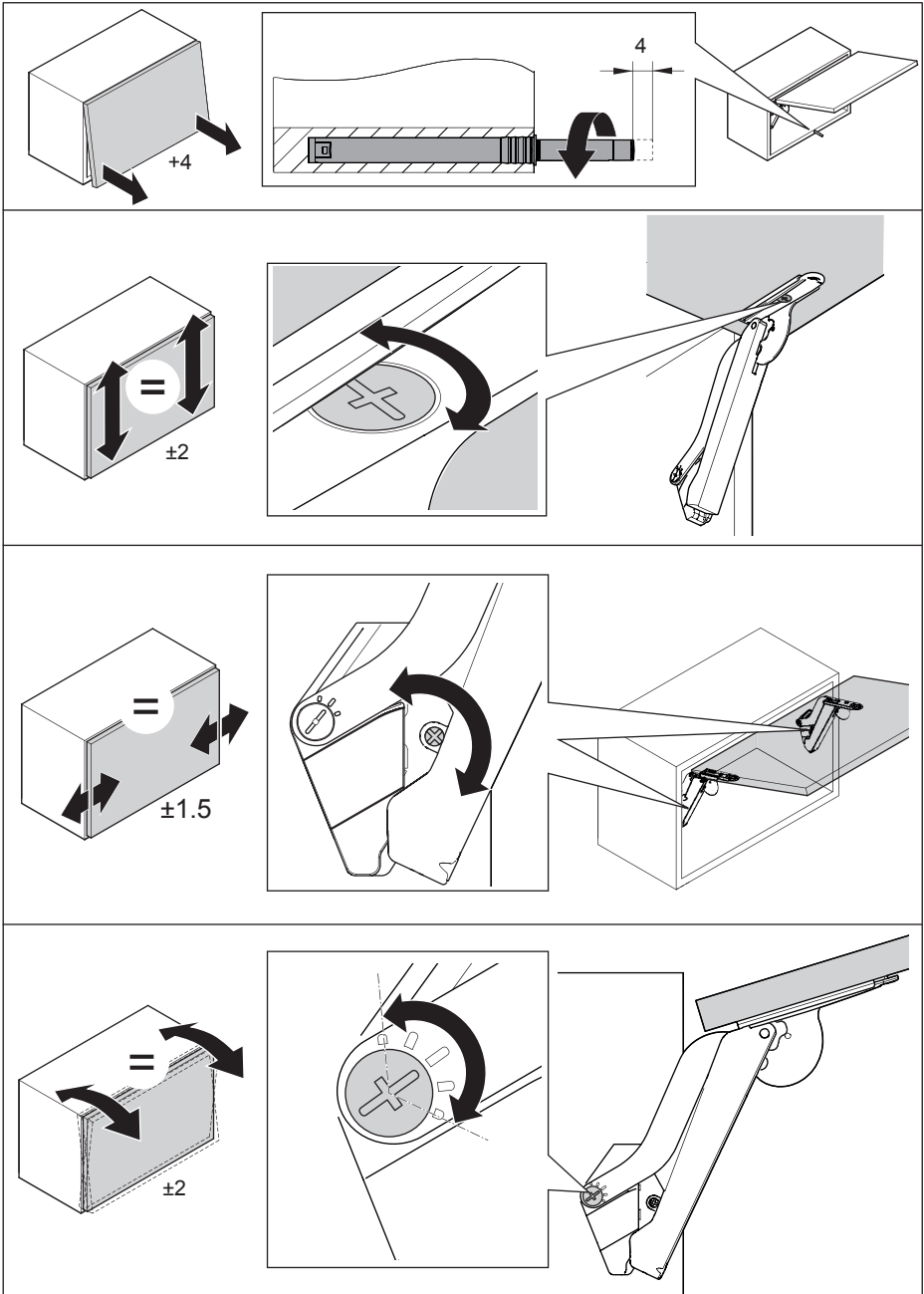

HDE 10.12.2019

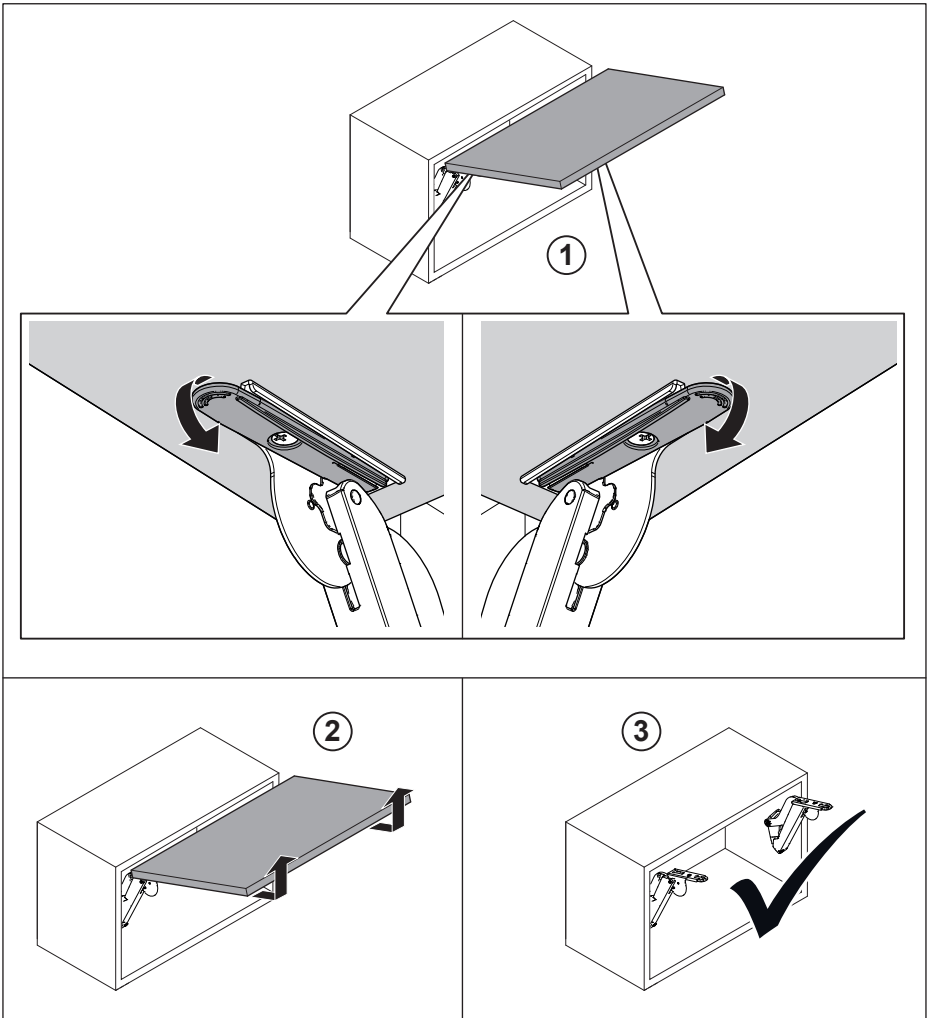

405457 0000

HDE 10.12.2019

