

1

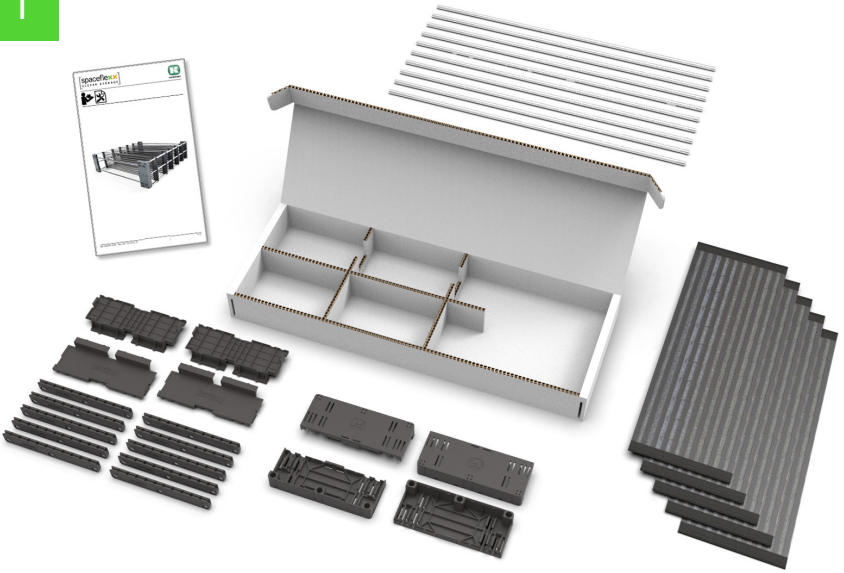

2

A = min 472 mm
B = min 472 mm
C = min 130 mm

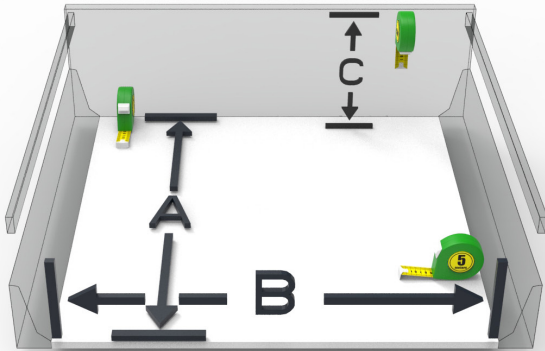

3

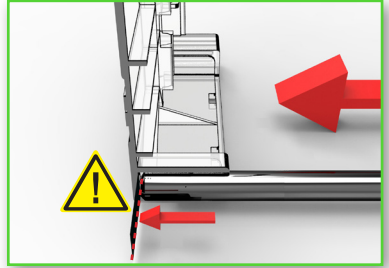

4

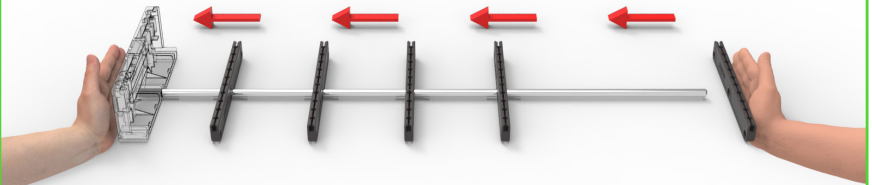
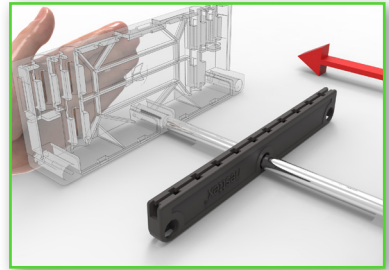

5

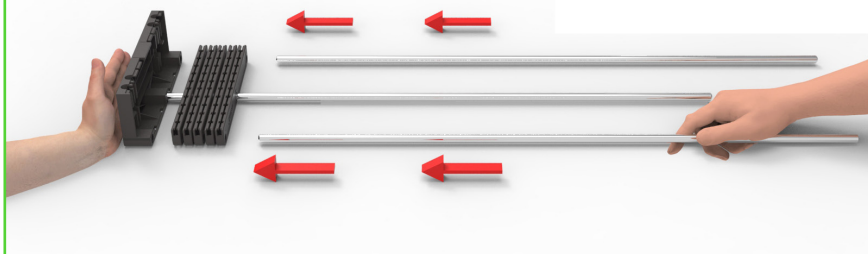
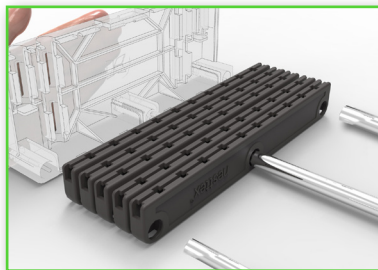

6



Naciśnij, aż się zatrzyma!
Bis zum Anschlag andrücken!
Press until it stops!

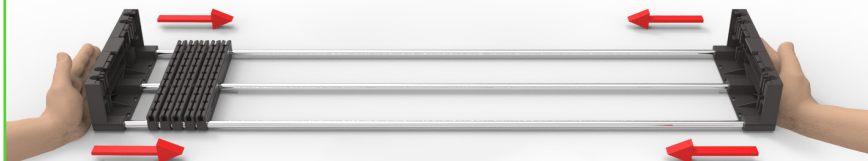

7

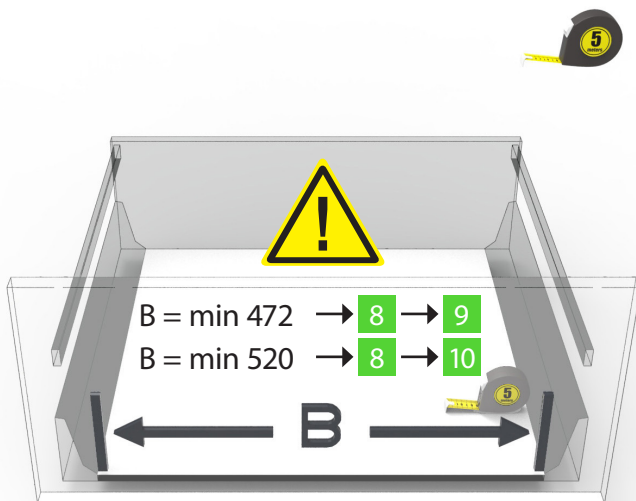

8



Montaż możliwy tylko w szufladzie!
Montage nur in der Schublade möglich!
Installation only possible in the drawer!

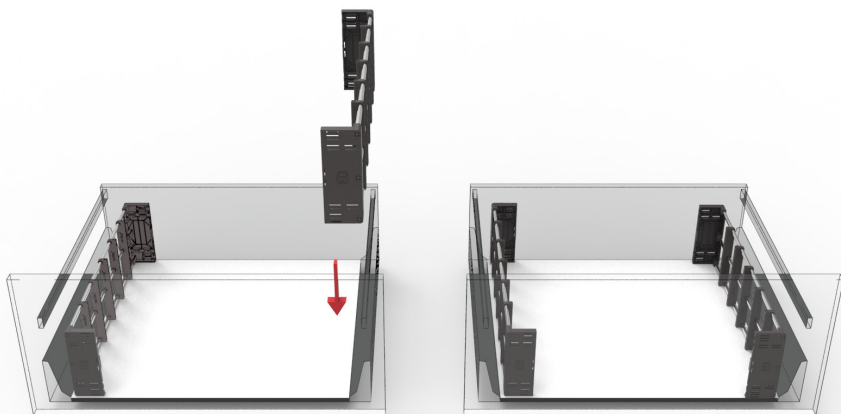

9

B = min 472 → 11

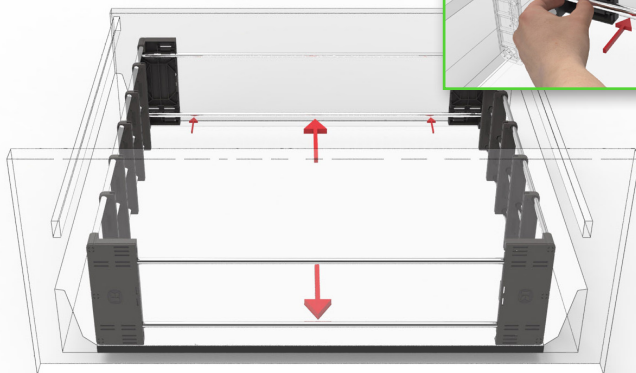

10

B = min 520 → 11

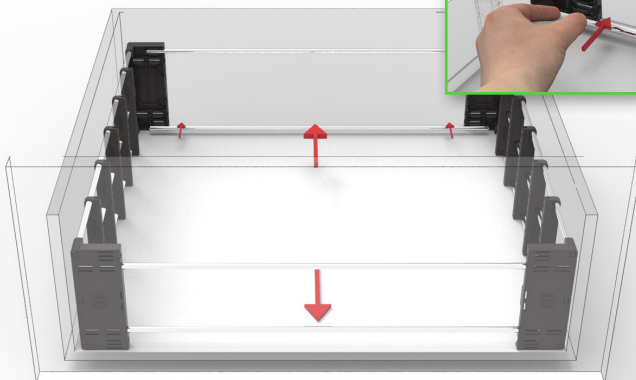

11

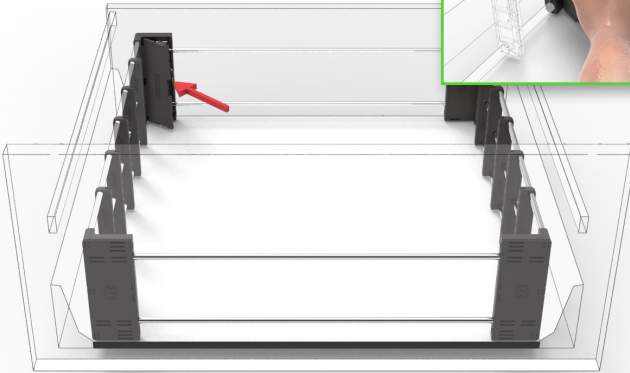

12

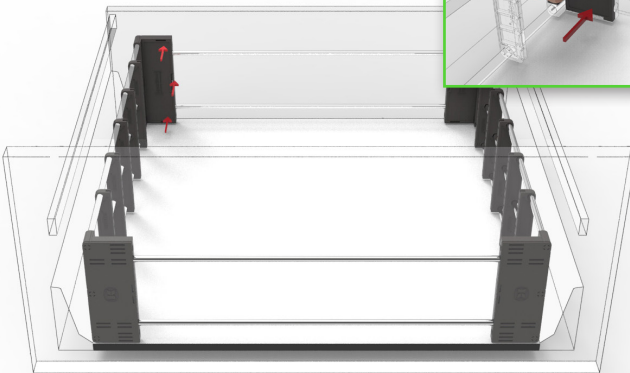

13

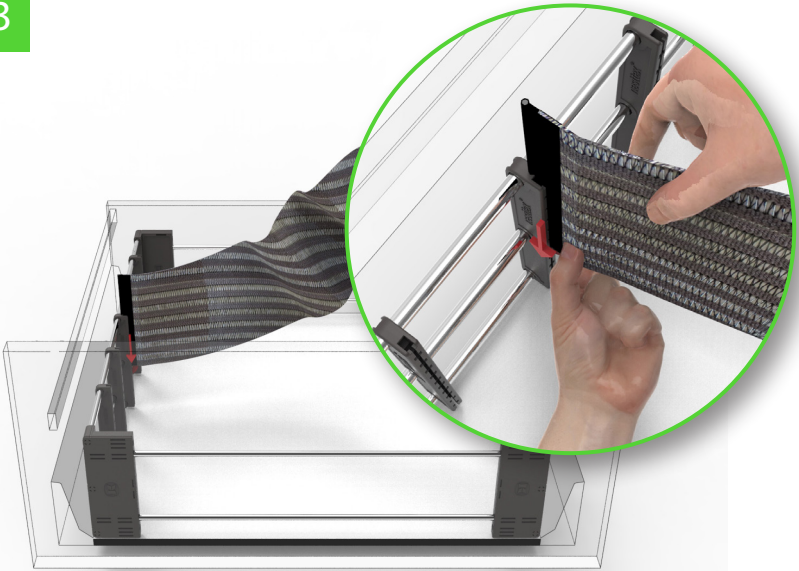

14

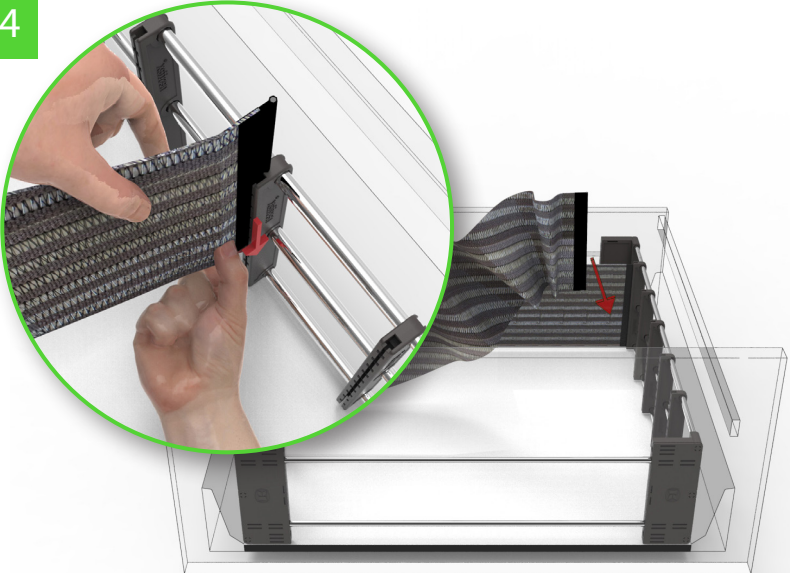

15





Przed wyjęciem z szuflady zdemontować zgodnie z opisem !

Vor Entnahme aus der Schublade das Produkt wie hier beschrieben demontieren!

Before removing from the drawer the product dismantle as described here!



1

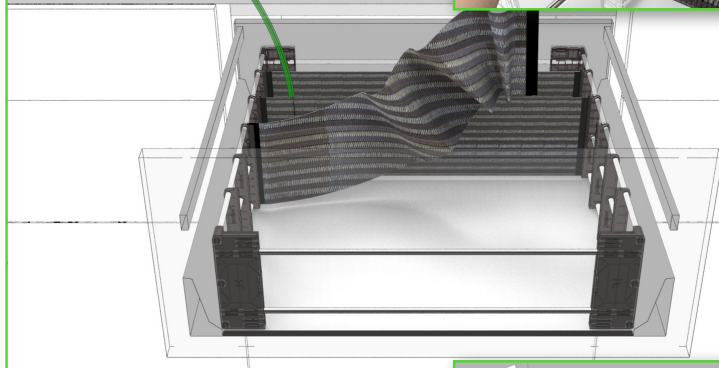
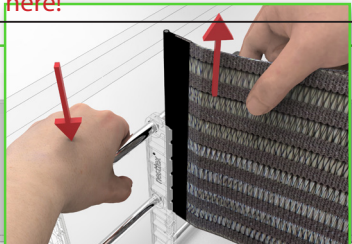
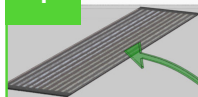

2

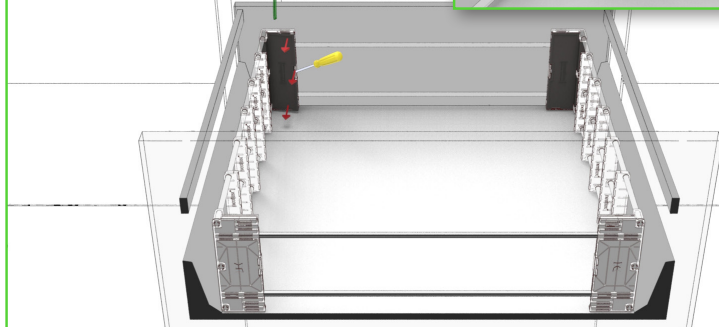
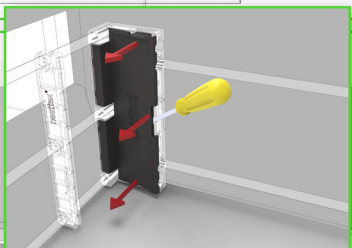
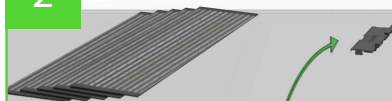



3

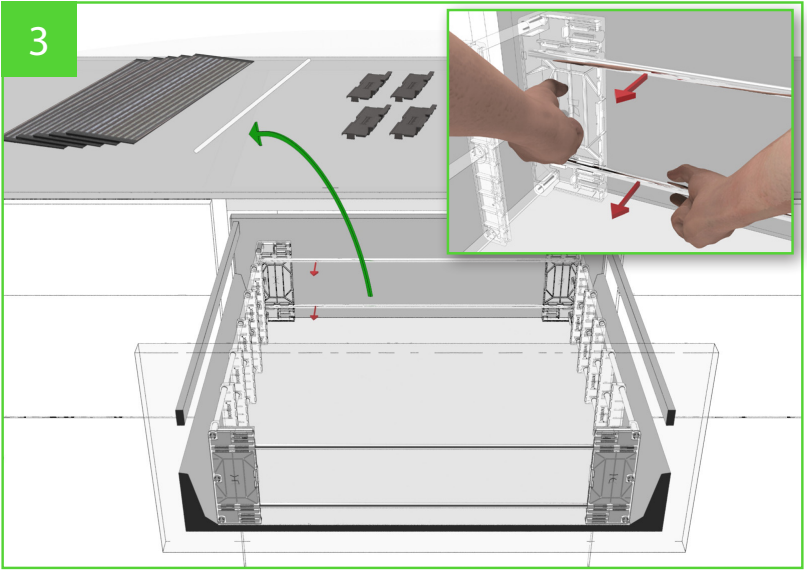

4

